

PAPER • OPEN ACCESS

The Mathematical Model of Autonomous System on Renewable Sources for Recreation and Relaxation of the Big Cities'

To cite this article: I Zicmane *et al* 2020 *IOP Conf. Ser.: Earth Environ. Sci.* **586** 012006

View the [article online](#) for updates and enhancements.

You may also like

- [Research on the Factors Influencing the Income Level of Urban Residents in Guangzhou](#)
Jiayi Zhong and Jiayi Zhong
- [Climate Change and Eco-Anthropocentric Approach to Architectural and Urban Planning](#)
M Eichner and Z Ivanova
- [Urbanization in Africa: challenges and opportunities for conservation](#)
Burak Güneralp, Shuaib Lwasa, Hillary Masundire et al.

A promotional banner for 'Free the Science Week 2023' featuring a dark blue background with a futuristic, glowing interface. A hand is shown interacting with a central circular element containing a padlock icon. The text 'Free the Science Week 2023 April 2-9' is in light blue, 'Accelerating discovery through open access!' is in white and light blue, and the ECS logo and website 'www.ecsdl.org' are in white. A blue button with white text says 'Discover more!'.

Free the Science Week 2023 April 2-9

Accelerating discovery through
open access!

 www.ecsdl.org [Discover more!](#)

The Mathematical Model of Autonomous System on Renewable Sources for Recreation and Relaxation of the Big Cities'

I Zicmane¹, K Berzina¹, T Lomane¹, I Zicmane² and N Berzina-Novikova³

1 Riga Technical University, Faculty of Electrical and Environmental Engineering, Latvia

2 Jāzeps Vītols Latvian Academy of Music, Latvia

3 Rīga Stradiņš University, Latvia

E-mail: inga.zicmane@rtu.lv

Abstract. Urbanization is a worldwide historical process that is related to the deep transformation of the existing cities and settlements. This process is based on the development of the industry, transport, housing, construction, as well as the spread of the urban way of living. Among the negative factors of urbanization, the following ones can be outlined: an active increase in environmental pollution by means of industrial emissions and waste, the lag of technological and sanitary welfare, as well as engineering communications, utilities and services from the housing stock growth, increase in level of city noise. Apart from the ever-increasing pollution levels of air, water and soil, an increased sociability aspect common for the urban community takes place. On the one hand, this characteristic brings positive influence and facilitates into the formation of a more balanced and stable nervous system of a younger generation, an improved mental fitness and the support of a professional and constructive tone. On the other hand, however, when processing an increased amount of information, a nervous system of a person is not able to recreate the previous operating state, when the level of adaptability was higher. This causes for a new dynamic stereotype to be formed, which in certain cases can lead to a disruption that can be found in neurosis and neurotic states. Despite the constantly accelerating pace of life, observed among urban residents, however paradoxical, a presence of hypodynamy can be distinguished, which influences the formation of cardiovascular disease.

The purpose of this publication is to develop a mathematical model of a new hybrid technology in the form of a modular autonomous house "Urbanrelax", which serves for the removal of an emotional overload and stress of urban residents. The aim, therefore, is to develop a system that would be supplied solely by renewable energy sources. Design of engineering communication and supply systems (including lighting, ventilation, light and music background, etc.) will be taken into account. As an outcome, a model of a complex system is planned based on the synergy of various science sectors such as energy, medicine, music, economy, etc., as well as smart grid technologies.

1. Introduction

The main negative factors of urbanization are both, environmental problems (pollution of the urban environment, increase of building density, decrease of the green area, etc.) and the destructive influence of the big city on human health (emotional discomfort and stress among inhabitants, mental overloads leading people to alienation from the urban environment, etc.). There is strong public interest in the quality of open urban spaces and it is acknowledged that they can contribute to the quality of life within cities, or contrarily enhance isolation and social exclusion [1,2].



Content from this work may be used under the terms of the [Creative Commons Attribution 3.0 licence](https://creativecommons.org/licenses/by/3.0/). Any further distribution of this work must maintain attribution to the author(s) and the title of the work, journal citation and DOI.

Stress is a nonspecific (general) reaction of the body to a very strong effect, whether physical or psychological, as well as the corresponding state of the nervous system of the organism (or the organism as a whole). The following types of stress are distinguished: neuropsychic, thermal or cold, light, anthropogenic and other types of stress. The immune system suffers from stress. An urban dweller of a large city daily experiences many times more stressful situations than a rural dweller. Infinite noise and hustle, aggressive bright illumination of billboards and shop show-windows, vibrations, a large crowd of people, etc., all this causes overstrain of the function of the vital systems of the human body, leads to the inability to adapt to them, the general oppression of the psycho-emotional background, accompanied by increased fatigue, apathy and irritancy.

The authors of the article conduct a brief analysis of the positive and negative influence of such integral factors of the big city impact as light, frequency and vibration on the psychosomatic state of a person with the possibility of solving the problem by introducing a new technology in the form of a modular autonomous house “urbanrelax” on renewable sources whose mathematical model is offered.

2. Prerequisites to research

The modern man himself creates complex urban systems, pursuing the good goal - to improve the living conditions, not simply “fencing” of the limiting factors, but also creating a new artificial environment that increases the comfort of life. However, this leads to the separation of the man from the natural environment, which in turn has a number of negative aspects of the impact, in particular, negatively affects the psychosomatic health of the city dweller.

The brain is a complex functional “apparatus” responsible for the coherent work of our psychism and bio-system. Each of our reactions, the ability to adequately think and act, and even the quality of thoughts and actions depend on the coherent work of all areas of this organ. Violation of harmony in the work of the brain system leads to an imbalance of hormonal activity in the body, an overabundance or lack of these regulators of certain processes [3].

Let us consider the main factors of the environmental impact on the psychosomatic state of a city dweller light and frequency.

2.1. Light

Living in a city, a person is forced to face daily the unfavourable videoecology. Until recently it was customary to assume that bright, especially natural light has a positive effect on the mood. However, recently in one of the scientific journals, experts have suggested that bright lighting in the room excites the human psyche, as a result of which the person can often cease to control his emotions. They, in turn, prevent to take an unbiased look at assessment of the situation and make a rational decision. In addition, the bright light, according to scientists, contributes to the emergence of stress and depression. At the same time, in medicine, therapies have been developed to use colour for a beneficial effect on human health based on practical experience. Already in 1948, the Swiss scientist Max Luscher published an original colour test, which is now known as the Luscher colour test [4].

Each colour (like any other part of the electromagnetic spectrum) has its own vibration, which has a corresponding physiological and psychological influence. The human eye is capable of perceiving only a small part of the known electromagnetic spectrum, the so-called optical (visible) range, Fig.1 and is configured to more closely see the three main colours - blue, green, and red [4].

Correct organization of lighting involves not only compliance with regulatory requirements on the level of illumination and a number of other indicators, but also taking into account a number of qualitative indicators of light saturation, uniformity and homogeneity of illumination, shadow formation, colour range of the light environment, etc [4].

Depending on the flicker frequency and colour range, light stimulation, as if “pressing” new rhythms on certain brain sections, can improve the flow of blood and the production of neurotransmitters in these sections of the brain, in particular serotonin, known as the hormone of happiness. And under the action of photostimulation by green colour, for example, on an individual alpha frequency, the normal heart rate and regulatory processes of the vegetative nervous system are normalized, which indicates the state of relaxation [4].

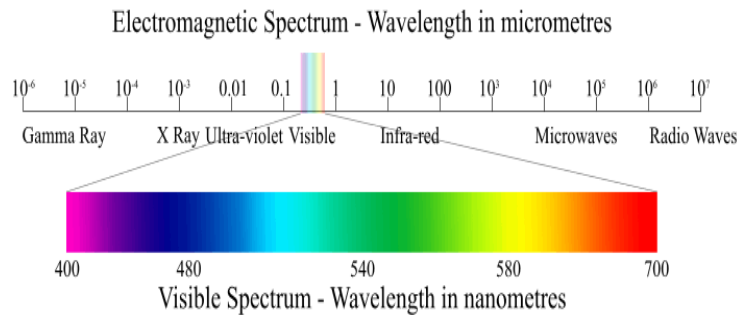

Figure 1. Visible range of electromagnetic spectrum.

2.2. Frequency

Sound is a mechanical wave propagating in elastic media: gases, air, fluids, and any solid materials. When propagating, it seems that the wave creates certain zones of stress in front of it, but behind it - the zones of discharge, which form oscillations - the frequency measured in Hz. One vibration per second = 1 Hz [4]. The human ear can perceive sounds in the range from 16 Hz to 20 000 Hz. All frequencies not perceived by the human acoustical apparatus up to 16 Hz refer to infrasound, and over 20 000 Hz to the ultrasound spectrum of wave oscillations [3]. On Figure 2 absolute thresholds of hearing and pain curves are presented (marked in red).

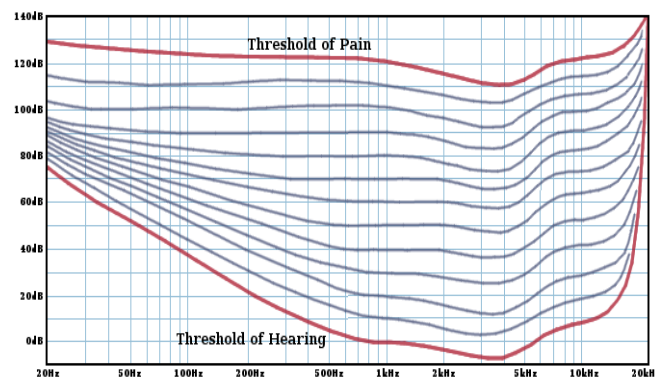

Figure 2. Phon scale with threshold of hearing and pain curves.

The brain activity of a live person does not stop even during deep sleep, and the brain constantly emits rhythmic waves, characterizing the processes occurring in it: [3].

- In the delta state (δ), the brain emits waves with a frequency of 0 to 4 Hz. It can be either a deep sleep without dreams, or a state of deep relaxation, an unconscious state (such as a coma), a lethargic dream.
- In the theta-state (θ), the frequency of the oscillations of the brain is from 4 to 7 Hz. It is deep relaxation or meditation; it may be a light sleep.
- The alpha state (α) is the frequency of wave oscillations of the brain from 7 to 14 Hz. The frequency range from 7 to 8 Hz is extremely hazardous to health, since this type of vibrations is able to provoke epileptic seizures, deadly damage the internal organs and even deform them. Prolonged impact on the brain of the sound at a frequency of 7 Hz has a detrimental effect on the heart, up to its arrest.
- The beta state (β) is 14-35 Hz. This condition of the brain is the most unproductive, because it characterizes stress, excitement.

- The active state of the brain produces wave oscillations at frequencies above 35 Hz (gamma-state).

Noise is a loud sound that merges into discordant sound. For all living organisms, including humans, sound is one of the environmental influences. The human ear does not hear the infrasound, but such a sound wave continues to exert a negative influence on the entire human body. The source of infrasonic waves can be wash of the waves and noise of crowns of trees during strong wind, deep earthquakes, road and rail transport, various industrial installations, ventilation shafts and so on, Fig. 3 [4].

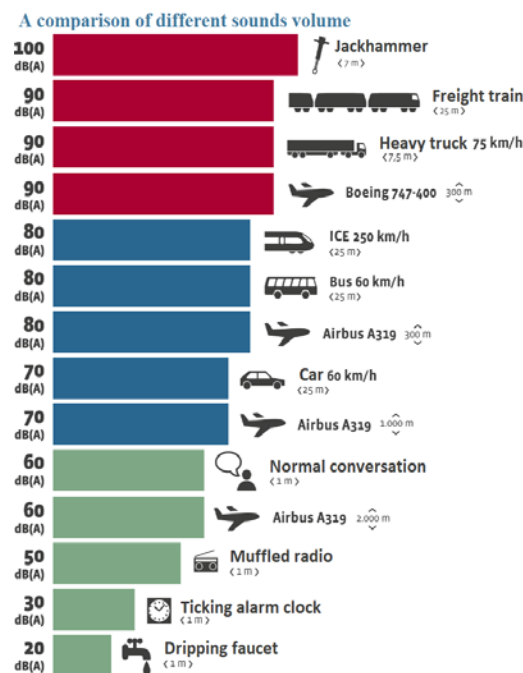

Figure 3. Volume of sounds from various sources.

Excessive volume of the sound wave is another destructive factor for health and psyche. The human ear is best suited for sound at 55-60 decibels. Loud sound is assumed to be at 70 decibels. But especially dangerous sounds are more than 95 dB - under their influence, vessels of the peripheral nervous system begin to sharply narrow, heart rhythm breaks down, headache, migraine appears, irritability increases sharply, passing into nervous breakdown and hysteria; while the balance of the adrenal and sex hormones (adrenaline, testosterone, pheromones and others) is heavily violated, the level of insulin in the blood is destabilized, the function of control over mental and somatic states is violated.

3. Impact of colour and music. Music and colour therapy research

The modern man himself creates complex urban systems, pursuing the good goal - to improve the living conditions, not simply “fencing” of the limiting factors, but also creating a new artificial environment that increases the comfort of life. However, this leads to the separation of the man from the natural environment, which in turn has a number of negative aspects of the impact, in particular, negatively affects the psychosomatic health of the city dweller.

The brain is a complex functional “apparatus” responsible for the coherent work of our psychism and bio-system. Each of our reactions, the ability to adequately think and act, and even the quality of thoughts and actions depend on the coherent work of all areas of this organ. Violation of harmony in the work of the brain system leads to an imbalance of hormonal activity in the body, an overabundance or lack of these regulators of certain processes [3].

Let us consider the main factors of the environmental impact on the psychosomatic state of a city dweller light and frequency.

In addition to the sound volume (dB), there are other features of it that have a scientific justification [4]:

- Height – amplitude.
- Duration – period.
- Tone quality – harmonics.
- Strength – intensity.
- Modal fitting.

Music is the process of changing acoustic forms, their origin, transformation, deformation and disappearance. The process of formation of acoustic forms, created by music, is studied by cymatics (in Greek, it means “wave”), a science that studies visible manifestations of sound and vibration in various environments [4]. With its rhythm, melody, harmony, dynamics, variety of sounds, colours and nuances, it transmits an infinite range of feelings and mood. The power of music is that, bypassing the mind, it creates a person's mood. According to its content music can, as well as enhance our mood, and sharply dampen it.

Music is a wave that has an effect on the brain and the whole body of a person by means of certain signals of the brain through neurons. Thus, the response to music is provided by the nervous system, interconnected with all human organs, especially for the normalization of the mental state. Music creates a special energy field that can carry a positive or negative charge depending on the volume, harmony, rhythmicity, frequency of the composition [4]. We will pay special attention to the last factor:

The 432 Hz tuning existed in ancient Greece. The first attempt to massively change the waves occurred in 1884, but the efforts of J Verdi the former system was retained, after which the setting “La” = 432 Hertz began to call “Verdi tuning”. Despite the fact that in some European countries tuning-forks still have a frequency of 432 Hz, the organization of ISO, setting standards to be followed by musical instrument producers at their setting and authors in writing music, adopted the 440 Hertz tuning as the main one - the concert. Today, the music we hear on radio and television, as well as the majority of audio records is produced at this frequency. At the same time, taking into account the impact on the psychosomatic state of a person, 432 Hz is the level of harmony and joy, the music played at this frequency relaxes, sounds clearer and more pleasant to hearing, while the level of 440 Hz works at the level of thinking.

Colour combined with music (sound) and music (sound) in combination with colour have a strong impact, much more than each separately. Numerous studies have shown that the combination of colour and sound has a deep and complex influence on both the psychophysiological state and the entire personal (psychic) sphere of a person, that is, to enhance the emotional impact on the listener, synchronization of sound, brightness of the light and its colour spectrum is applied.

In modern light and music equipment, the correspondence of colour to sound is constructed according to this traditional principle of dividing the frequency range of sound into channels (correspondence is optional, just traditionally developed) [4].

- Red — the range up to 20-400 Hz.
- Orange — the range from 400 to 800 Hz.
- Yellow — the range from 800 to 1600 Hz.
- Green — from 1600 to 3000 Hz.
- Light blue — of 3000 – 8000 Hz.
- Blue — 8000 – 12000 Hz.
- Violet — 12000 – 20000 Hz.

4. Theoretical background and practical approach

The aim of this paper is to analyse the feasibility of creating an autonomous micropower energy installation solely operating on solar and wind energy, which are the most universal and throughout available renewable energy sources. The development of such a fully autonomous efficient energy

installation is directly related to the search and justification of its optimal configuration and composition, taking into account the actual climatic conditions of operation, the characteristics of the equipment used, as well as the characteristics of the consumer, including the expected variable schedules of energy consumption. The criterion of optimality should be the minimum cost of an energy installation with guaranteed energy supply to the consumer. The solution of the problem of creating such optimal autonomous energy installations is possible only on the basis of a combination of computational, theoretical and experimental studies [5-11].

The tasks of stabilizing the frequency and voltage of alternating current of an autonomous energy installation are determined by the following factors:

- Direct connection of the electric generator to the prime motor; nonstationary nature of the energy flow.
- Commensurability of load power with generator drive power.
- Random nature of load changes. In power supply systems of stable frequency, the currents and voltages of the electric generator change during operation both in amplitude and shape. This circumstance substantially complicates the calculation of the converting load of the electric generator.

Such a system includes a solar module or, for example, a small wind generator, an accumulator with a charger, supplying the devices with direct current [12].

In accordance to the aforementioned technical and spatial requirements for the proposed building, a power system model is developed. Taking into account the required autonomous functionality of an electrical grid, as well as the need to reduce CO₂ emissions of a system, only renewable energy sources (RES), along with the battery storage, will be considered as a valid supply option. As shown in Fig. 4, for the purpose of AC and DC power supply, a PV array and a wind turbine generator will serve to meet the power demand requirements.

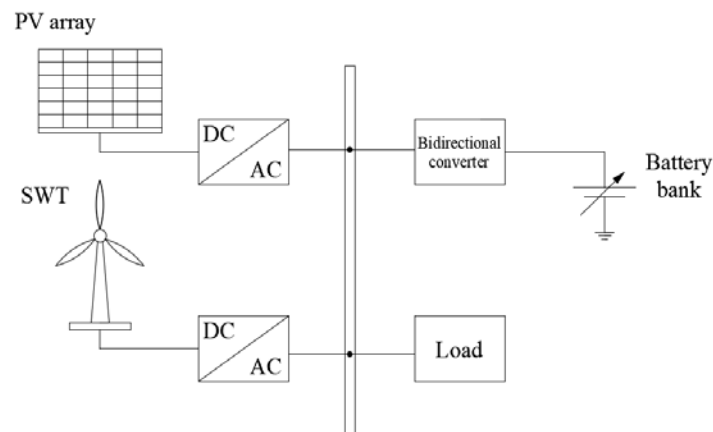

Figure 4. Simplified representation of an autonomous grid

The power of autonomous systems and the capacity of their batteries are selected according to individual needs. Advantages: ease of installation, advanced technology, easy operation and maintenance. Since a standard household load of 220V AC is used for the electricity supply (lighting, audio system, various household devices are expected to be in use, such as a water heater, air cooler, and humidifier. It should be noted that the control system comprised of sensors, dimmers, etc. is envisaged as well), then for more reliable and comfortable power supply it is advisable to use a hybrid power system with solar batteries and a liquid fuel generator, which should include, in addition to solar batteries: an inverter, a charge controller and a charging device for recharging the accumulator battery (AB). Also, in order to increase energy efficiency, it is possible to introduce an automatic stop

and start-up system of the generator depending on the degree of charging of the AB in such hybrid power systems [12].

Taking into account the most common shortcomings of the optimization complexes of stand-alone power systems (SPS) [13], a problem arose for the development of a model taking into account: a sufficiently detailed graph of consumer loads, stochastic intensity of solar radiation, ambient temperature, electrical losses, basic operational parameters of the SPS, as well as the random nature of wind speed dynamics. Realization of such a model allows implies the following required tasks [14]:

- Selection of auxiliary equipment.
- Determination of the optimal ratio of generating capacities.
- Choose the optimal size of equipment.

The authors developed a model of the SPS using renewable energy sources. The model is implemented in the simulation environment of MATLAB.

4.1. Load modeling

Living In order to account for all the possible loads, an average summer period daily load curve was used. The data for the required calculations was obtained from the Latvian distribution grid maintainer “Sadales tikls”. In order to obtain the averaged load curve, calculation methods from [13] were implemented.

As the standard load curve is given by “Sadales tikls” in per unit system, it is easy to obtain the real active power values from it. In Fig. 5 the result is presented.

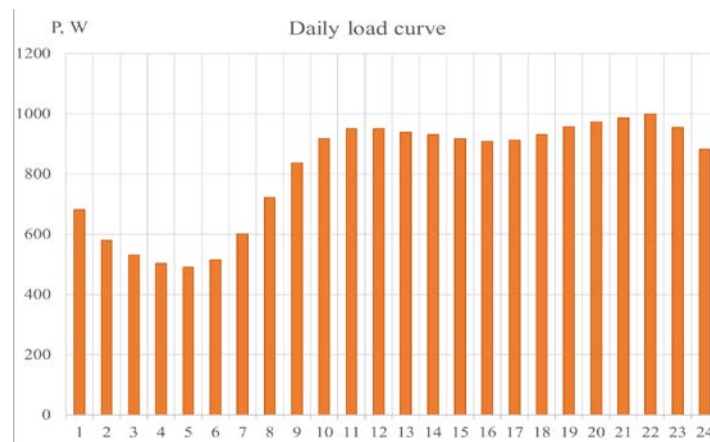

Figure 5. Total daily load curve.

4.2. Load PV array performance model

Before the assessment of a PV array performance the solar panel module has to be chosen in order to obtain the rated power value. The actual power output, which depends on solar irradiance and module temperature, can then be calculated by the system of equations presented in [13].

In order to find out the exact power at a given time, solar irradiance data is required. For the purpose of estimating the power output at a given time, Photovoltaic Geographical Information System (PVGIS) was used.

Solar irradiation during winter is relatively small in Latvia, and the angle of solar rays is suboptimal. This results in an increased energy loss due to higher reflection rate of solar panels. Therefore, the proposed model for the autonomous house implies its usage only during summer months: June, July and August. Fig. 6 depicts the difference in production during summer and winter. From the graph, it can be seen that summer output is relatively similar along the months; therefore an average curve was derived.

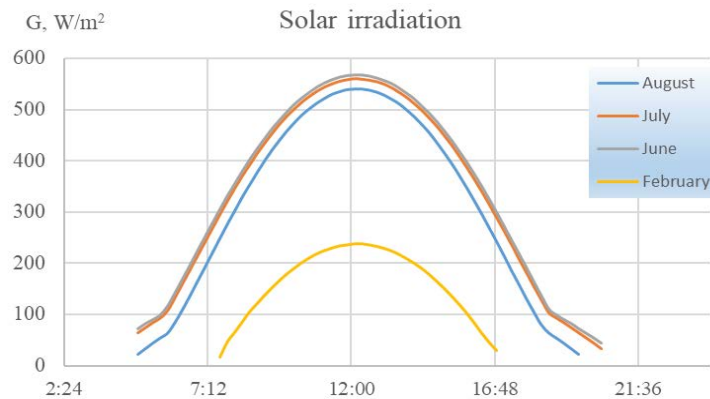

Figure 6. Daily load curve with PV power output

4.3. Wind turbine performance model

The type of wind turbine, chosen for the task stated in this work, is small wind turbine (SWT). This choice was dictated by the expected working conditions and the location of building in question. After the assessment of current SWT market state it was concluded, that the most popular design is a fixed speed wind turbine with stall controlled blades and a DC generator [15].

A wind resource bears a probabilistic nature, hence, the distribution of frequencies of different wind speeds should be assessed. An hourly wind data of summer months was obtained from the Latvian Environmental Geological and Meteorological Centre. The gathered measurements were made in the capital of Latvia, Riga, at a height of 10 meters. Histogram in the Fig. 7 shows that the most frequent wind speeds at the site are 2, 3 and 4 m/s. Electrical power output from the wind turbine generator can be calculated by the following expression [16]:

$$P_w = \eta_g \cdot \frac{1}{2} \cdot \rho_a \cdot C_p \cdot A \cdot V_w^3 \quad (1)$$

where V_w – wind speed, ρ_a – air density, C_p – wind turbine power coefficient, A – turbine rotor swept area, η_g – generator efficiency.

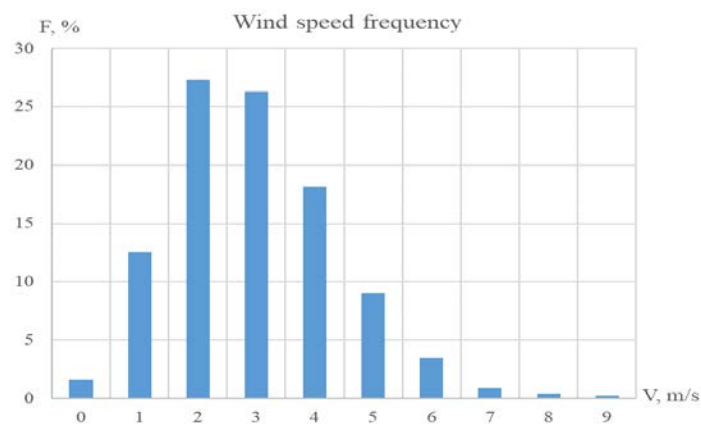

Figure 7. Dominant wind speed values at the selected site.

From Fig. 7, the most frequent wind speed is 2 m/s. At this speed SWT would yield a total power density of 16.5 W/m². In this case the only possible solution would be to increase the blade length, so as to increase the rotor swept area. In turn, it would result in turbine producing more power at its active state.

From the energy production distribution graph, shown in Fig. 8. it can be seen, that despite the prevalent V_{wi} of 3m/s, the biggest amount of energy is expected to be produced during wind speeds of

4 and 5 m/s. The red graph on the Fig. 8 was obtained by simply multiplying the wind hours by the according output power value.

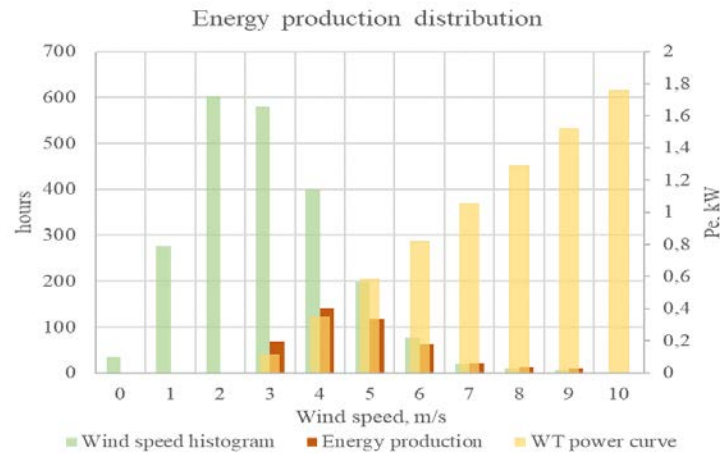

Figure 8. Wind turbine power curve wind speed and energy production distribution.

Using the average daily wind profile data, an expected wind generator output is calculated. Fig. 9 shows the average hourly wind speed for every month of a summer. As the curves are relatively similar, a single approximate hourly wind profile curve is calculated in order to evaluate possible wind energy output.

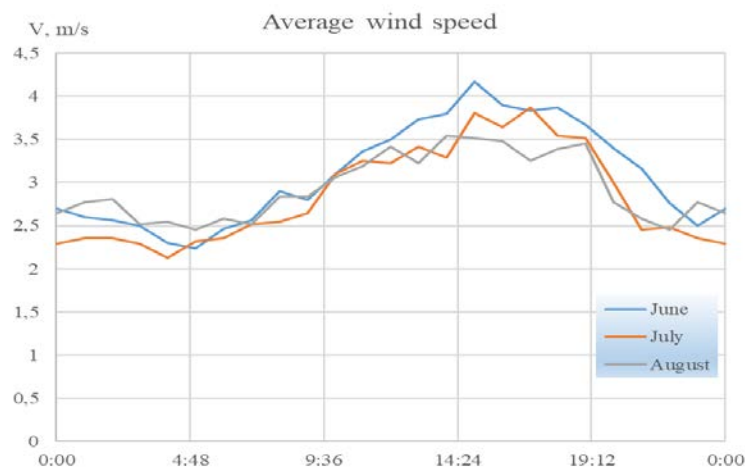

Figure 9. Hourly wind profiles for each summer month.

4.4. Power balance and battery storage

The main requirement for the proposed system presumes constant power balance of the grid, which means that at any sampling interval i , the sum of supplied powers from PV, WT and batteries must be equal to the one being demanded. Therefore, the main condition for a properly operating system is the ability to supply sufficient power at all times:

$$P_{PV} + P_{WT} + P_{bat} = P_{load} \quad (2)$$

Fig. 10 shows that solar arrays and wind turbine alone are not able to meet the demand during the time period $t = 18:00 - 6:00$. Using the power balance expression (7), a lacking power values are obtained. A peak of those values would then define the required rated discharge power. Assuming that during the inactive state of solar panels (at time period $t = 18:00 - 6:00$), the battery module would be main energy source, a safety factor should be accounted for the possibility of a windless weather. Fig. 10 details the discharge rate of battery storage. Adding up the values of supplied power during the discharge period, a storage capacity can be calculated. However, it should be noted that state-of-the-art

battery technologies are not tolerating a completely discharged state, as it would significantly shorten the lifetime of a battery.

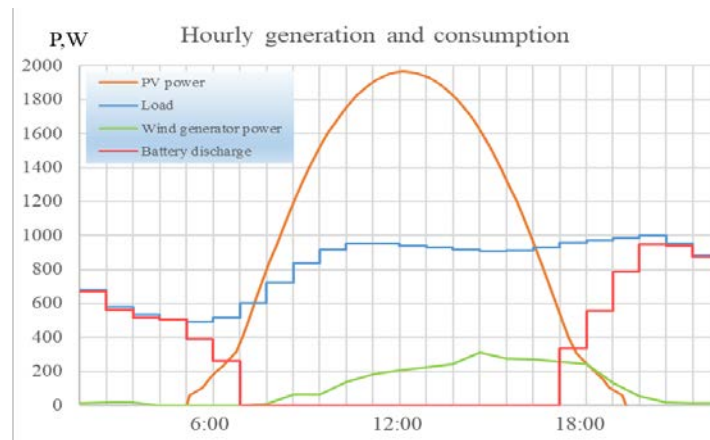

Figure 10. Battery storage expected working cycle.

The maximum depth of discharge value is therefore adopted from the [17] and it amounts to 80%. The required energy value during the downtime of main supplier (PV) and the obtained value in the charging mode during the surplus of daylight solar radiation were calculated with the methodology, presented in [18-20].

The state of charge (SOC) of battery can be calculated from the equations (10), (11) [16].

For the discharging period:

$$E_b(t) = E_b(t-1) \cdot (1 - \sigma) - ((\sum P_{gen}(t) / \eta_i - P_{load}(t))) \quad (3)$$

For the charging period:

$$E_b(t) = E_b(t-1) \cdot (1 - \sigma) + (\sum P_{gen}(t)_i - P_{load}(t) / \eta_i) \cdot \eta_b \quad (4)$$

For the purpose of calculating hourly SOC of storage (Fig. 11.) the parameters of lithium battery bank CES POWERGRID PG11 and inverter Sunny Island 4.4M were used.

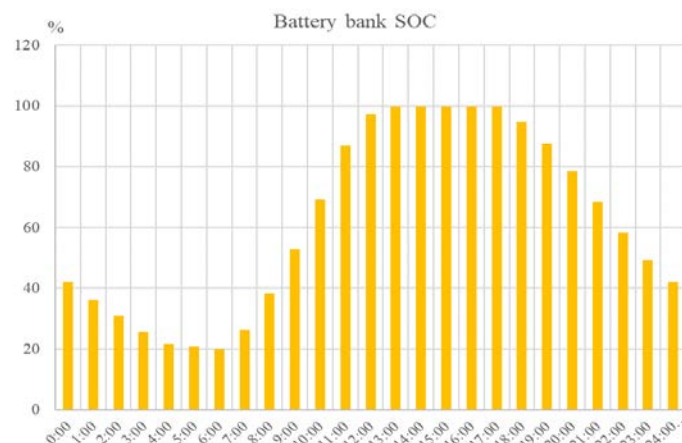

Figure 11. Battery storage state of the charge over rated capacity during the 24-hour period. From the SOC graph (Fig. 11) it is clear that the depth of discharge does not exceed the allowable value. The visible plateau that is established in a time period $t = 13:00 - 17:00$ is a product of a battery bank control system so as to not allow overcharging.

5. Economical modeling

For hybrid generation systems, the most important concern is to achieve the lowest energy cost, and the economical approach can be the best benchmark of cost analysis. Several methods are used to get different options for energy system; the levelized cost of energy is often the preferred indicator. However, the method is not easy to apply in a practical application because it is very complicated. In this study, a simple economical model is developed. Let M_i be the output power of i th individual generation system that constitutes the hybrid system per Wh, and n be the total number of the generation systems in the hybrid system. Also let E_i be the generation capacity of i th individual generation system. The total cost per Wh, M_{tot} , can be expressed as follows [21]:

$$M_{tot} = \sum_{i=1}^n M_i E_i + M_{bat} C, \quad (5)$$

where M_{bat} is the cost of battery per Wh, and C is battery capacity.

6. Conclusion

- The influence of sound in combination with the influence of colour and light can be successfully applied to harmonize both the mental and physiological state of an urban dweller of a large city.
- Purposeful application of music and light pulses can have an effective controlling (motivating) effect on the indices of a person's psychosomatic state.
- The model of an autonomous house for relaxation, supplied by exclusively renewable energy sources "urbanrelax" proposed in this paper was assessed with the help of meteorological data gathered from the capital of Latvia, Riga. Despite seemingly poor wind and solar energy potential in the implied geographical location, the model, considered in this paper, estimated able operation during summer period.
- The urgency of the development of such a model is that even at the design stage of a SPS, it becomes possible not only to solve the problem of choosing the optimal ratio of generating capacities, but also to verify the operability of the SPS.
- Evaluating the SOC graph, it is clear that due to the specificity of a load curve used for calculation, a required battery storage would work inefficiently during certain periods, when solar energy is in abundance, overcharging the cells. This implies the necessity to include dump load modules in the system. However, a more efficient solution should be considered by creating the formation of multiple relaxation house models in a microgrid. This could allow for a more optimal energy consumption and balanced operation, as well as allow using bigger wind turbine generators.
- Small wind turbines currently cannot be considered a viable option for a primal energy supply source. With an average cut-in speed of 3m/s and a tower height of 10m, the possibility of them operating at rated parameters is very small.
- Installation of the proposed autonomous house for relaxation in a busy city area would have a positive impact on overall psychological state of residents, while generating positive attention and interest towards renewable technology. In length of time, the amount of customers for renewable energy technologies is expected to increase; thus, increasing the percentage of consumed "clean" energy and reducing CO2 emissions.
- A technique for optimizing an SPS using renewable energy sources is presented. On the basis of the described technique, a mathematical model of an SPS is implemented. The developed model allows solving optimization problems, namely, finding the optimal ratio of generating capacities, choosing the optimal unit size of equipment, choosing the installed capacity of auxiliary equipment.

7. References

- [1] Tzu Ping Lin 2009 Thermal perception, adaptation and attendance in a public square in hot and humid regions *Building and Environment* **44**(10) pp.2017-2026

- [2] M J Alcoforado H Andrade A Lopes J Vasconcelos 2009 Application of climatic guidelines to urban planning: The example of Lisbon (Portugal) *Landscape and Urban Planning* **90(1-2)** pp 56-65
- [3] Anonymous 2014 The influence of music, sound and vibration on the psyche and human consciousness *Online* <http://ayfaar.org/news/item/594-vliyanii-muzyki-zvuka-i-vibratsii-napsikhiku-i-soznanie-cheloveka>
- [4] Anonymous 2015 The influence of sounds, music and color on self-awareness and human health. *Online* https://ayfaar.ru/articles/vliyanie_zvukov_muzyki_i_cveta_na_samosoznanie_i_zdorove_cheloveka
- [5] O Popel 2006 Stand-alone power plants using renewable energy sources *Proceedings of Institute of Higher Temperatures (RAS Power Supply)* 3 pp 70 – 75
- [6] Anonymous 2016 Optimal energy efficient power supply system sizing methodology *Online* <https://lektsii.org/13-7078.html>
- [7] O. Arkhipova V Kovalev P Remizov 2014 Modelling of autonomous power systems. *Modern problems of science and education* 6 621.311.
- [8] M Tsitoura T Tsoutsos D Kolokotsa D 2010 Comfort conditions in urban open spaces in Crete 3rd Palenc, 5th EPIC and 1st Cool Roofs Conference pp 29-30
- [9] A Vyblov B Lukutin S Obukhov E Shandarova E 2011 Power balance in autonomous power supply system *Online* <http://rudocs.exdat.com/docs/index-41554.html>
- [10] A Zvezdov B Krylov G Martirosov V Presnov V Salnikov I Fedik V Chernyshev 1997 Method of operation of an autonomous power plant on a renewable energy source. 11 *Online* <http://www.freepatent.ru/patents/2095913>
- [11] S Mitrofanov A Nemaltsev 2016 Method of power calculation of the autonomous solar power plant for the needs of energy saving and efficiency laboratory lighting *Online* <http://docplayer.ru/46435896-Metodika-rascheta-moshchnosti-avtonomnoy-solnechnoy-elektrostancii-dlya-nuzhd-osveshcheniya-laboratorii-energoberezheniya-i-energoeffektivnosti.html>
- [12] S Burian N Zykova 2015 Hybrid power supply system *Research Journal «European Research prepared (the VIII International Scientific and Practical Conference "European Research: Innovation in Science, Education and Technology")* **7(8)** 2410-2873
- [13] I Zicmane K Berzina J Kuckovskis N Berzina-Novikova I Zicmane 2017 The Model of Places for Recreation and Relaxation of People Taking into Account the Urboecological Aspects of Evolution of a Modern City *11th International Conference on Electromechanical and Power Systems SIELMEN* pp 385-390
- [14] A Narziev A Iskandarov 2016 Improvement of autonomous system of the electrical supply, maintaining renewable power sources *International scientific review* **3(13)** 2542-0798
- [15] R Carriveau 2012 Advances in Wind Power *In Tech*
- [16] S Ashok 2007 Optimized model for community-based hybrid energy system *Renewable Energy Elsevier* **32(7)** 0960-1481
- [17] V Velkin A Zavyalov E Starikov 2014 Computation of autonomous power supply system for nuclear power plant reserve. *Online* <http://docplayer.ru/56966771-Raschet-avtonomnoy-fotoelektricheskoy-siste-my-elektrosnabzheniya-dlya-rezervirovaniya-sob-stvennyh-nuzhd-aes.html>
- [18] K Berzina I Zicmane A Sobolevskis 2017 Optimal PV Electrical Energy Storage of Office Building's Communal Space Lighting *IEEE 17th International Conference on Environment and Electrical Engineering and 1st Industrial and Commercial Power Systems Europe* pp1-5
- [19] I Zicmane K Berzina A Mahnitko A 2018 Mathematical Model for Autonomous Power Supply Systems on Renewable Sources for Remote Power Users *International Conference on Intelligent and Innovative Computing Applications (ICONIC)* pp1-5
- [20] I Zicmane K Berzina 2018 A Mathematical Model of Optimal Modes of Operation of an Autonomous Energy Complex for a Typical Graph of Changes in the Energy Loads of a

Consumer *International Conference and Exposition on Electrical And Power Engineering (EPE 2018)* pp 1-5

- [21] J H Lim 2012 Optimal combination and sizing of a new and renewable hybrid generation system *International Journal of Future Generation Communication and Networking* **5(2)** pp 43-59